







USER'S MANUAL
series MPA-MPV/P6



 011/9664616

ME2004_12
06/10

INDEX

INDEX -----	3
 1.0 GENERAL POINTS -----	4
1.1 TECHNICAL CHARACTERISTICS -----	4
1.1.1 DISPLAY SIGNALS -----	4
1.2 CONNECTION DESCRIPTIONS -----	5
WIRING DIAGRAM FOR CURRENT INPUT -----	7
WIRING DIAGRAM FOR VOLTAGE INPUT -----	7
 Instal 2.0 INSTALLATION NOTES -----	8
2.1 INSTALLATION PROCEDURE -----	8
2.2 HOW TO OPERATE -----	8
2.3 RECOVERY TARA FUNCTION -----	9
2.4 MACHINE OPERATION WITH FIXED ZERO -----	10
2.5 INSTRUMENT SET UP -----	10
2.6 DEFAULT PARAMETERS (dEF) -----	14
 V-A 3.0 ANALOGUE OUTPUT -----	14
3.1 TECHNICAL CHARACTERISTICS -----	15
3.2 INSTALLATION OF ANALOGUE OUTPUT -----	15
3.3 NOTES ON ANALOGUE OUTPUT SET UPS -----	16
 P-W 4.0 PASSWORD FUNCTION -----	17
 Prog. 5.0 SET UP -----	18
 6.0 NOTES -----	18



1.0 GENERAL POINTS

The instruments of the MPA and MPV series in the P6 type container (75mm depth) can be ordered with the ammeter type scale (MPA) or the voltmeter scale (MPV) for D.C. or A.C. input. The main characteristics are as follows:

- two alarms with exchange relay output
- 14V not regulated for 2 wire transducer power supply
- alarm programming and 6 key calibration on instrument front panel for ease of use
- 9999 point display
- the 'hold' function operates directly from the terminal board (with memory of value displayed) and ' tara recovery ' (automatic zeroing).
- possibility of programming delay time and hysteresis alarms using hidden menu which is password protected.
- possibility of fixed zero setup
- programmable analogue output in voltage (0-10V) or current output (0-20mA or 4-20mA)

1.1 TECHNICAL CHARACTERISTICS

Table 1

Input	4÷20 mA input imp.: 20 Ω voltage input imp.: 1MΩ
Transducer supply	14Vdc, 20mA
Alarm output	exchange relay 250 Vac 5 A static NPN / PNP 50 mA 30 Vcc
Analogue output	0÷10V, 0÷20mA o 4÷20mA 12 bit of resolution
Power Supply	90÷ 260 Vac/Vdc, 25 Vac 50 ÷ 60 Hz 12 ÷ 30Vdc
Dimension	48 x 96 x 75
Mounting Plate	44.5 mm (height) x 92.5 mm (length)

1.1.1 DISPLAY SIGNALS

LO: reading less than -2000

HI: reading above 9999

Err: outside input scale or input scale malfunctioning

Err 9: menu parameters wrongly set up

1.2 CONNECTION DESCRIPTIONS

KEYBOARD DESCRIPTION

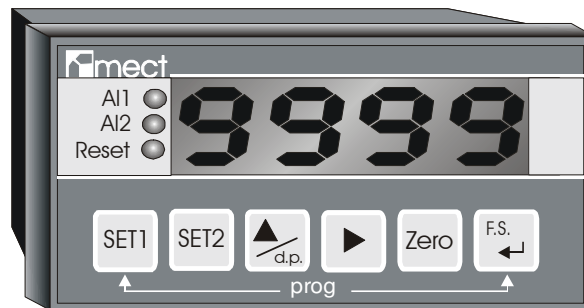

SET1

: alarm setup 1

SET2

: alarm setup 2



: increments blinking digit in menu or decimal point set-up



: shifts blinking digit in menu

Zero

: setup of reading scale start point



: set up of reading scale end point

SET1

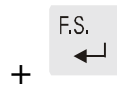

+ : menu access point

TERMINAL BOARD DESCRIPTION

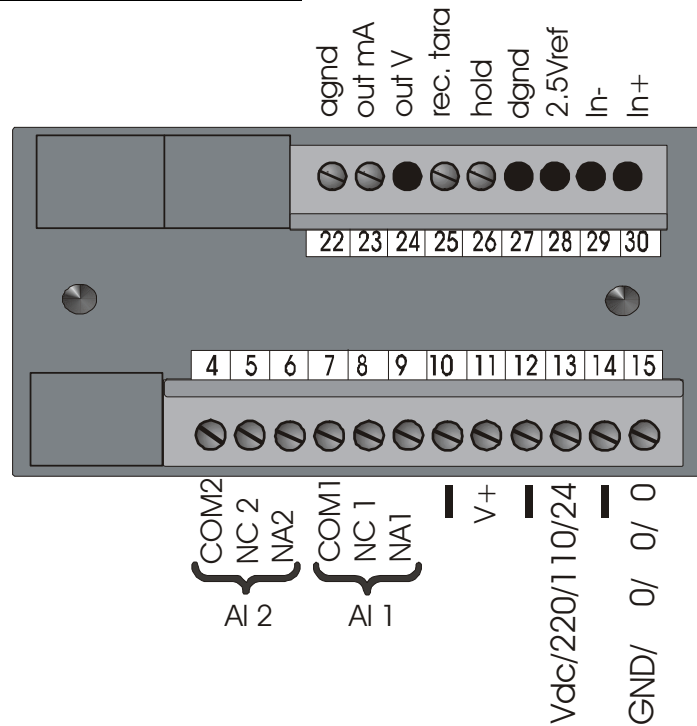

- Terminals 4,5,6 - alarm output 2
- Terminals 7,8,9 - alarm output 1
- Terminal 11 - transducer power supply (14V)
- Terminals 13 and 15 - instrument power supply (25Vac, 90÷ 260Vac/Vdc) in dc power supply, terminals 13 is positive and 15 negative. If power supply “Vcc” the terminal 15 ≡ terminal 29
- Terminals 29 and 30 - input measure
- Terminal 28 - potentiometer power supply (MPP)
- Terminals 22, 23 and 24 - analog outputs (if requested)
- Terminal 26 - Hold: shortcircuiting terminals 26 and 27 will memorize the reading
- Terminal 25 - Recovery tara:
 - 1) Terminals 25-27 open: the reading is the same as the programmed values
 - 2) Terminals 25-27 closed: at the moment the terminals become shortcircuited the display is zeroed (rec.tara)

WIRING DIAGRAM FOR CURRENT INPUT

1) Connection for 2 wire transducer

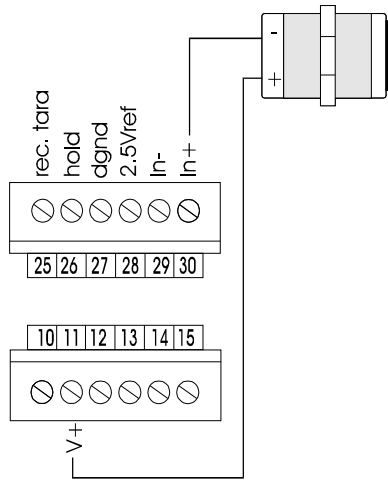

2) Connection for 2 wire transducer with external power supply

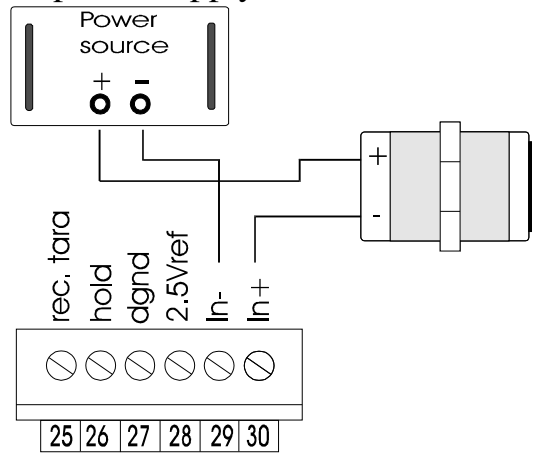

3) Connection for current input

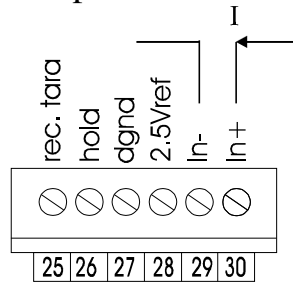

WIRING DIAGRAM FOR VOLTAGE INPUT

1) Connection for 3 wire transducer

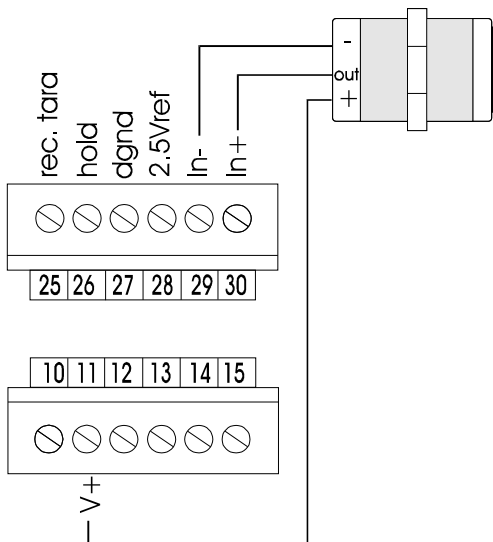

2) Connection for 3 wire transducer with external power supply

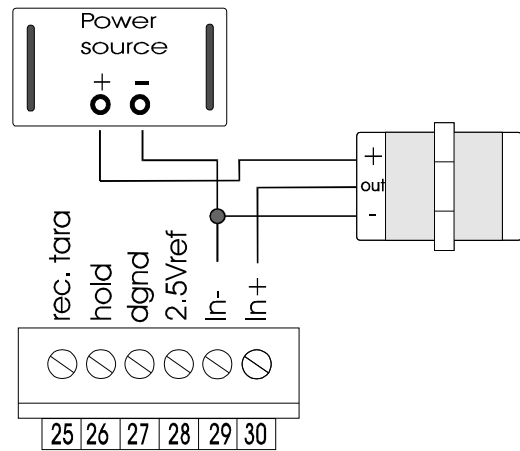

3) Connection for voltage input

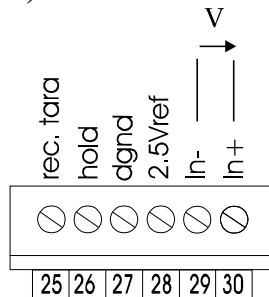
**2.0 INSTALLATION NOTES****2.1 INSTALLATION PROCEDURE**

- 1- Undertake the linkups on page 2
- 2- Switch on the instrument
- 3- Use the zero key to set up the value that must coincide with the minimum input value (stated instrument value; 4mA for the MPA15-22 instruments)
- 4- Use the zero key to set up the value that must coincide with the maximum input value (stated instrument value; 20mA for the MPA15-22 instruments)
- 5- Use the d.p. key to set up the decimal point as required
- 6- Use the SET1 key to set up alarm value 1
- 7- Use the SET2 key to set up alarm value 2.
- 8- The instrument is now ready for use.
- 9- For automatic zeroing check the recovery Tara function.
- 10- To install other input or alarm parameters see the instrument setup paragraph.
- 11- To set up the analogue output (if required) see the analogue output paragraph.

2.2 HOW TO OPERATE

Please use the specific keys on the front in order to calibrate the instrument. With the ZERO key set up the reading value that is in line with the beginning of the input scale (for MPA15-22 this is 4mA), then with the F.S. key set up the reading value which coincides with the base input scale (for MPA15-22 this is 20mA), with the Set1 and Set2 keys set up the alarm values and finally with the dp key you should set up the decimal point.

WARNING : This type of programming can be realized by using the SET1, SET2, d.p., ZERO, and FS keys if the keys are enabled. The SET1 and SET2 values can span only between lower and upper limits.

See the paragraph “Instrument Setup”.

There now follow examples of zero calibration which are also true for end scale and alarms using the personalized keys F.S., SET1 and SET2.

1st OPERATION
 Touch the zero key. The display will visualize the value which it keeps in memory with the first left hand digit flashing.

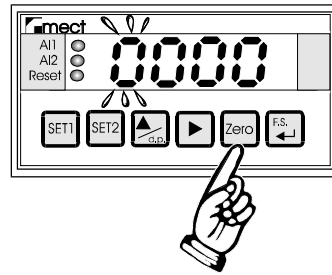

2nd OPERATION
 Touch the “▶” key to move the flashing number to the right.

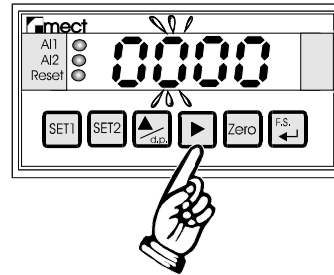

3rd OPERATION
 Touch the “▲” key to increase the flashing value.

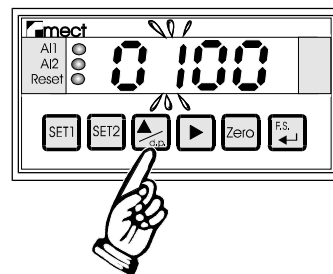

4th OPERATION
 Confirm the programmed number by touching the 'zero' key.

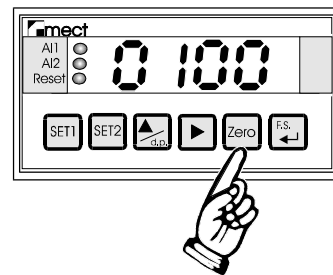

To program the decimal point observe the following indications.

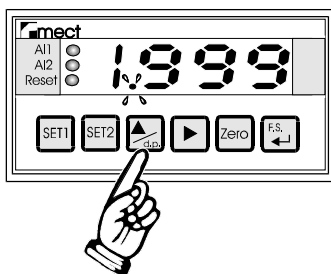

Touch the ▲ key with the instrument in measuring mode. A decimal point will light up. In order to move this point touch the indicated key until the desired point is reached

2.3 RECOVERY TARA FUNCTION

For “Recovery Tara” we mean a function that when in use zeroes the instrument readings. The Recovery Tara function with terminals 25 and 27 open is not in use and in these circumstances the instrument reading is linked to the programming

parameters ISL, FSL and OFFS. At the moment when the terminals 25 and 27 are short circuited zero is displayed and the reading zeroed. This operation is indicated when the led 'Reset' lights up on the instrument front.

Let us assume that the instrument, linked to a transducer, indicates a 100kg number. Shutting down the connection between terminals 25 and 27 will zero the instrument reading, thus rendering the indications negative for weight values that are less than 100 Kg and positive for values that are greater than 100 Kg.

N.B. The “reset display” function clears the current display value by the menu item “nert” il is possible to store the clear value at power off.

2.4 MACHINE OPERATION WITH FIXED ZERO

The instrument can be programmed to visualize the range $-1990 \div 9990$ with the units number blocked at zero. To set up this function it is necessary to programme 'on' using the hidden menu item ZEFI (see table 2).

2.5 INSTRUMENT SET UP

By using a hidden menu which is accessed by pushing together the two keys SET1 and F.S., it is possible to programme certain items of secondary importance which are protected by a password code and which can be useful for certain display values or for alarm functions. These setups are explained in the following table.

IMPORTANT

For the programming of the instrument display parameters there are four codes: ISI, ISL, FSI, and FSL. These menu items allow the setup of the co-ordinates which process the instrument readings. The first coordinate is formed by ISI and ISL. ISI is the initial value of the input scale which coincides with that written in the instrument label (0 mA, 4 mA, 0 V, Etc..) while ISL is the corresponding instrument display value. The second coordinate is formed of FSI and FSL. FSI is the bottom scale input value which coincides with that written on the instrument label (20 mA, 100 mV, 10 V, etc..), while FSL is the corresponding instrument display value. After calibrating the instrument it is possible to correct any unbalances in the transducer by using the menu item “OFFS”.

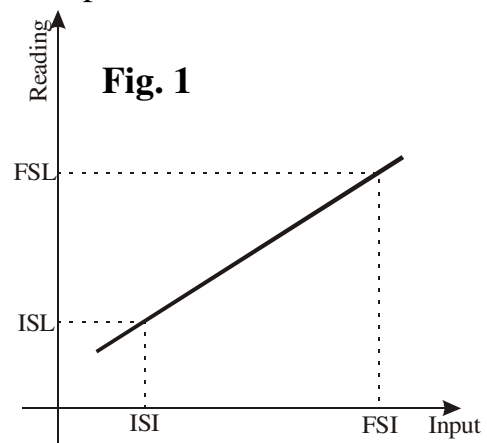

Table 2

n seq.	Touch key	Written on display	NOTE
1	FS ↵ + SET1	PASS	Touch FS ↵ + SET1 keys for some seconds
2	FS ↵	0 000	Digit the personal password ** (confirm with " FS ↵")

n seq.	Touch key	Written on display	NOTE
3	▲	CPAS	CHANGE PASSWORD (if required see paragraph)
4	▲	AbSP	SET POINT IN USE
5	FS ↵	on	on = Set1 and Set2 keys in use oFF = Set1 and Set2 keys out of use To change use "▲" key and confirm with "FS ↵"
6		AbSP	
7	▲	AbOF	ZERO AND END SCALE IN USE
8	FS ↵	on	on = zero and FS keys in use; OFF = zero and FS keys out of use. To change use "▲" key and confirm with "FS ↵"
9		AbOF	
10	▲	AbPd	DECIMAL POINT IN USE
11	FS ↵	on	on = d.p. key in use; OFF = d.p. key out of use. To change use "▲" key and confirm with "FS ↵"
12		AbPd	
13	▲	ISI	START INPUT SCALE
14	FS ↵	0000	Insert the input value with which should represent the initial scale reading. For instruments MPA 15-22 write 4.00. ** (confirm with "FS ↵")
15		ISI	
16	▲	ISL	START READING SCALE
17	FS ↵	0000	Insert the reading value which coincides with the input value. ** (confirm with "FS ↵")
18		ISL	
19	▲	FSI	END INPUT SCALE
20	FS ↵	1999	Insert the input value with which should represent the end scale reading. For instruments MPA 15- 22 write 4.00. ** (confirm with "FS ↵")
21		FSI	
22	▲	FSL	FULL SCALE READING
23	FS ↵	1000	Insert the reading value which coincides with the input value. ** (confirm with "FS ↵")
24		FSL	
25	▲	OFFS	ZEROING
26	FS ↵	0000	Use this item to effect a zeroing that will be retained in memory. The number written can vary between - 999 and 1999. ** (confirm with "FS ↵")
27		OFFS	
28	▲	LSPL	LOWER LIMIT SETPOINT

n seq.	Touch key	Written on display	NOTE
29	FS ↵	0000	Setup the lower limit for the alarm value **(confirm with " FS ↵")
30		LSPL	
31	▲	LSPH	UPPER LIMIT SETPOINT
32	FS ↵	0000	Setup the uppers limit for the alarm value **(confirm with " FS ↵")
33		LSPH	
34	▲	rL1	EXCHANGE RELAY 1 SET UP
35	FS ↵	nA	nA = normal open relay; nC = normal closed relay To change this use the "▲" key and confirm with " FS ↵"
36		rL1	
37	▲	HY1	HYSTERESIS ALARM1
38	FS ↵	200	Set up required hysteresis (see Fig.2) with a number between 0 and 200 digits. ** (confirm with " FS ↵")
39		HY1	
40	▲	Sd1	DELAY SELECTION RELAY 1
41	FS ↵	no	no = no delay time; EC = switch on delay; di = switch off delay; ECdi = delay switch on + off To change use the "▲" key and confirm with " FS ↵"
42		Sd1	
43	▲	dL1	DELAY TIME ALARM 1
44	FS ↵	20.0	Set up required delay with number which varies between 0 and 20.0 seconds.
45		dL1	
46	▲	rL2	EXCHANGE RELAY 2 SET UP
47	FS ↵	nA	nA = normal open relay; nC = normal closed relay . To change use the "▲" key and confirm with " FS ↵"
48		rL2	
49	▲	HY2	HYSTERESIS ALARM 2
50	FS ↵	200	Set up required hysteresis (see Fig.2) with a number between 0 and 200 digits. ** (confirm with " FS ↵")
51		HY2	
52	▲	Sd2	DELAY SELECTION RELAY 2
53	FS ↵	no	no = no delay time; EC = switch on delay; di = switch off delay; ECdi = delay switch on + off . To change use the "▲" key and confirm with " FS ↵"

n seq.	Touch key	Written on display	NOTE
54		Sd2	
55	▲	dL2	DELAY TIME ALARM 2
56	FS ↵	20.0	Delay set up for period between 0 and 20.0 secs. ** (confirm with " FS ↵")
57		dL2	
58	▲	ZEFI	FIXED ZERO SELECTION
59	FS ↵	on	OFF=standard display ON=fixed zero display . To change use the "▲" key and confirm with " FS ↵"
60		ZEFI	
61	▲	SEL.A	ANALOGUE OUTPUT SCALE
62	FS ↵	4 20	4 20= analogue output 4÷20mA; 0 20= analogue output 0÷20mA; 0 10= analogue output 0÷10V. To change use the "▲" key and confirm with " FS ↵"
63		SEL.A	
64	▲	IS	BEGINNING SCALE READING (ANALOGUE OUTPUT)
65	FS ↵	0000	Write down the reading value where the analogue scale output begins (ISO) ** (confirm with " FS ↵")
66		IS	
67	▲	FS	END SCALE READING (ANALOGUE OUTPUT)
68	FS ↵	1000	Write down output value which coincides with FSO value. ** (confirm with " FS ↵")
69		FS	
70	▲	ISO	BEGINNING SCALE READING (ANALOGUE OUTPUT)
71	FS ↵	00.00	Write down output value which coincides with IS value. ** (confirm with " FS ↵")
72		ISO	
73	▲	FSO	END SCALE READING (ANALOGUE OUTPUT)
74	FS ↵	10.00	Write down output value which coincides with FS value ** (confirm with " FS ↵")
75		FSO	
76	▲	nErt	MEMORIZING DISPLAY CLEAR FUNCTION

n seq.	Touch key	Written on display	NOTE
77	FS ↵	On	On = memorize the display clear function at the switching off OFF = the instrument loses the display clear function value at the switching off Press “▲” key until you will see the req. item **(confirm with " FS ↵")
78		nErt	
79	▲	dEF	DEFAULT PARAMETERS (see paragraph)
80	FS ↵	on	on= default parameter setup; OFF=no def.param. set up. To change use "▲" key and confirm with " FS ↵"
81		dEF	
82	▲	“measure”	

** To modify the preset number follow the procedure shown under the 'SETUP' paragraph.

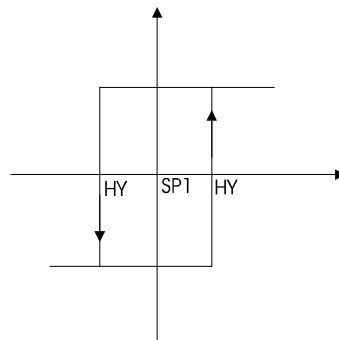

Fig. 2

2.6 DEFAULT PARAMETERS (dEF)

The instrument will signal erroneous setups with the Err9 display. In order to retrieve the situation as quickly as possible it is advisable to put the dEF function into use, which resets all the functions to factory default standards by eliminating all error situations.

WARNING: Setting up this function eliminates all the current instrument programming.



3.0 ANALOGUE OUTPUT

The MPA-MPV/P6 instruments can be ordered with a voltmeter and ammeter analogue output point (“OAP” options).

The flexibility of use and the comprehensive keyboard programming make this output an important interface between analogue computer input, recorders or repeaters with analogue input.

In particular the programming functions enable one to choose differing output (0÷10V, 0÷20mA, 4÷20mA) and the appropriate reading calibration. The maximum voltage that the instrument can use is 10V positive and is automatically limited in the programming phase. In addition the maximum current output generated is at most 20mA while in both cases there are no limits for furnishing intermediate values.

In order to set up the analogue output the user must install the two reading values (IS and FS) and the corresponding output values (ISO and FSO). It is necessary to know that for larger or smaller reading values to those programmed the analogue output values cannot exceed the values setup under the ISO and FSO programme values (output values).

For further clarification we would ask you to follow the examples shown in the paragraph 'Analogue output setup'. The analogue output instantly follows the display visualisation and is therefore blocked the moment in which the terminal board hold comes in and it takes account of the numbers zeroed using the 'Recovery Tara' function.

3.1 TECHNICAL CHARACTERISTICS

Table 3

Analogue output	0÷10V - 0÷ 20mA - 4÷20mA
Maximum current output impedance	400 Ω
Minimum voltage output impedance	1K Ω
Maximum voltage supplied	10 V
Maximum current supplied	20mA
Resolution	12 bit

3.2 INSTALLATION OF ANALOGUE OUTPUT

To use the analogue output correctly it is necessary to carefully follow the following instructions:

1- Set up the connections as shown in Figure A for the ammeter output otherwise the connections shown in Figure B for the voltmeter output.

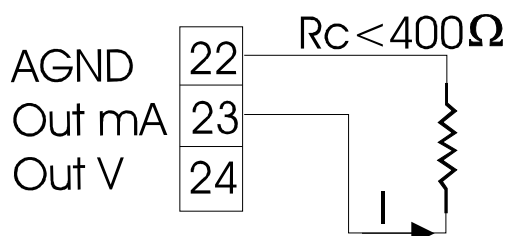

Figure A

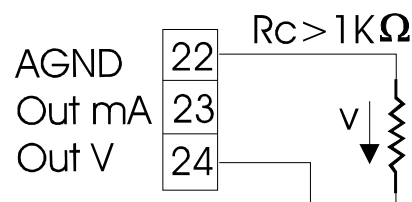

Figure B

2- Program the menu items related to the analogue output (see table 2) and follow, eventually, the examples explained in the paragraph 'Notes on analogue output

setup'. To undertake this programming it is necessary to take account of the following:

ISO (beginning of output scale) is the value of the analogue output which coincides with the number programmed under the menu item 'IS'. Make sure to load under the 'IS' heading the display value which coincides with the initial value of the analogue output (ISO). The ISO programming item should be programmed on the basis of the output selected. As a consequence we can obtain:

- ISO = 00.00 V for voltmeter output
- ISO = 00.00 mA for the ammeter output (for 4-20mA output this item need not be programmed)

FSO (end scale output) is the value of analogue output which coincides with the number displayed under the menu item FS. Digit under the FS item the display value which should correspond with the final value of the analogue output (FSO). The menu item FSO should be programmed on the basis of the type of output required.

As a consequence we are able to obtain:

- FSO = 10.00 V if voltmeter output
- FSO = 19.99 mA if ammeter output (for 4-20mA output the voice is not programmable).

3.3 NOTES ON ANALOGUE OUTPUT SET UPS

- Program the instrument to function with the following calibrations:

DISPLAY: -500; AMMETER OUTPUT: 5mA

DISPLAY: 500; AMMETER OUTPUT: +15mA

The instrument parameters must be set out as follows.

SEL.A = 0 20

IS = -500

FS = 500

ISO = 5.00*

FSO =15.00*

* with the instrument readings below -500, the analogue output remains fixed at 5mA, while with the reading above 500 the analogue output remains fixed at 15 mA.

- Program the instrument to function with the following calibrations:

DISPLAY: -500; AMMETER OUTPUT: 4mA

DISPLAY: 500; AMMETER OUTPUT: 20mA

The instrument parameters must be set out as follows.

SEL.A = 4 20

IS = -500

FS = 500

ISO = not programmable*

FSO = not programmable*

* with the instrument readings below -500, the analogue output remains fixed at 4mA, while with the reading above 500 the analogue output remains fixed at 20 mA.

- Program the instrument to function with the following calibrations:

DISPLAY: -1000; VOLTMETER OUTPUT: 2V

DISPLAY: +1000; VOLTMETER OUTPUT: 6V

The instrument parameters must be set out as follows.

SEL.A = 0 10

IS = -500

FS = 500

ISO = 2.00*

FSO = 6.00*

* with the instrument readings below -500, the analogue output remains fixed at 2V, while with the reading above 500 the analogue output remains fixed at 6V.



4.0 PASSWORD FUNCTION

The user should save the programmed information from misuse by using the password function.

The instrument comes supplied with a password code =0, but any number between 0 and 9999 can be set up as an access code in order to modify the instrument functioning (for programming personal password number check with the following table).

The use of the password code is requested each time the user wishes to gain access to the programming functions. The instrument, after having obtained the password number then behaves in two different ways.

- 1) **correct N.Pass** The user can use the programming menu in order to modify a function or number.
- 2) **incorrect Pass** The user can gain access to the programming menu only in order to check the numbers and functions already programmed, but never to modify them.

WARNING. The number programmed under the c.PAS menu item by the user must be reinserted under the PASS heading each time that the programming menu is used for insertion of the variables. If the user does not remember the exact secret code, then it is necessary to call our service centre.

Table 4

n seq.	Touch Key	Written on display	NOTE
1	FS ↵	PASS	Touch “ FS ↵” key
2	FS ↵	0 000	** (confirm with “ FS ↵2)
3	▲	C.PAS	PERSONAL PASSWORD NUMBER

4	FS ↵	0 000	Enter Password Number between 0 and 9999 . ** (confirm with “ FS ↵”)
5		C.PAS	
6	▲	“measure”	Touch “▲” key until you exit the menu

** To modify the preset number follow the procedure shown under the 'SETUP' paragraph.



5.0 SET UP

The following paragraph shows the steps necessary for programming the various menu items. The example that follows is related to programming under the 'CPAS' menu item, but the procedure is valid for all the menu items that need a numerical setup.

Table 5

n seq.	Touch Key	Written on display	NOTE
1		CPAS	Example of password change
2	FS ↵	0 000	The display appears as a flashing number)
3	▶	0 0 00	Pressure on the “▶” key moves the flashing number right
4	▲	0 1 00	Pressure on the “▲ “ key increases the flashing number
5	FS ↵	CPAS	The number is memorized and the display returns to selected menu item



6.0 NOTES

The instrument does not have a power on switch and a fuse, but it immediately switches on when the correct voltage is applied (see the operating voltage on the instrument label). Keep the power line separate from the signals lines.

For security reasons, it is necessary to provide externally a two phases switch and a protective fuse near the instrument with easy access for the user.

Avoid the presence of others power elements, humidity, acid, heat sources, etc..

Mect srl is not responsible for damages to humans or goods for an improper use of the instrument or not conforming to the characteristics of its instrument.

In mect srl there is an help desk office.