

USER'S MANUAL

series

MP40 101 P6

MP40 102 P6









MECT

 +39 011 9664616

ME2052_03

12/11

INDEX

INDEX -----	3
 1.0 GENERAL POINTS -----	4
1.1 TECHNICAL CHARACTERISTICS -----	4
1.1.1 DISPLAY SIGNALS -----	4
1.1.2 CONNECTION DESCRIPTIONS -----	5
1.1.3 WIRING DIAGRAM -----	7
 Instal 2.0 INSTALLATION NOTES -----	8
2.1 INSTALLATION PROCEDURE -----	8
2.2 HOW TO OPERATE THE INSTRUMENT -----	9
2.3 RECOVERY TARA FUNCTION -----	10
2.4 INSTRUMENT SET UP -----	11
2.5 POTENTIOMETER INPUT SET UP -----	14
2.5.1 THEORETICAL EXAMPLE -----	14
2.5.2 PRACTICAL EXAMPLE -----	14
2.6 FIXED ZERO FUNCTION -----	15
2.7 DEFAULT PARAMETERS (dEF) -----	15
 Filtro 3.0 FILTER FUNCTION -----	15
 P-W 4.0 PASSWORD FUNCTION -----	16
 Prog. 5.0 SET UP -----	16
 6.0 NOTES -----	17



1.0 GENERAL POINTS

The multiscaling instruments of the MP40P6 series in the P6 type container (75mm depth) can be ordered with :

- model MP40 101 for inputs:
 - 0÷10Vdc
 - 0÷2Vdc
 - TA/5Aac
 - potentiometer input
- model MP40 102 for inputs:
 - 0÷10Vdc
 - 0÷2Vdc
 - 4/0÷20mA
 - potentiometer input

The main characteristics are as follows:

- 14V not regulated for 2 wire transducer power supply
- set up with 4 keys on instrument front panel
- 9999 point display
- the 'hold' function (with memory of value displayed) and ' tara recovery ' (automatic zeroing) operate directly from the terminal board.
- possibility of fixed zero setup

1.1 TECHNICAL CHARACTERISTICS

Table 1

Input	4÷20 mA: impedance input: 20 Ω 0÷10Vdc: input impedance 1MΩ potentiometer input and 0÷2Vdc: input impedance ∞ TA/5Aac: input impedance 0,01 Ω
Reading for dc inputs:	-1999 ÷9999
Reading for ac inputs:	recommended: 0 ÷3200; possible: 0 ÷9999
Transducer supply	14Vdc, 20mA
Power Supply	115 Vac, 230 Vac, 25 Vac 50 ÷ 60 Hz 12 ÷ 30Vdc standard or optoisolated
Dimension	48 x 96 x 75
Mounting Plate	44.5 mm (height) x 92.5 mm (length)

1.1.1 DISPLAY SIGNALS

UFL: reading less than -2000

OFL: reading above 9999

LO/HI: outside input scale or input scale malfunctioning

1.1.2 CONNECTION DESCRIPTIONS

KEYBOARD DESCRIPTION

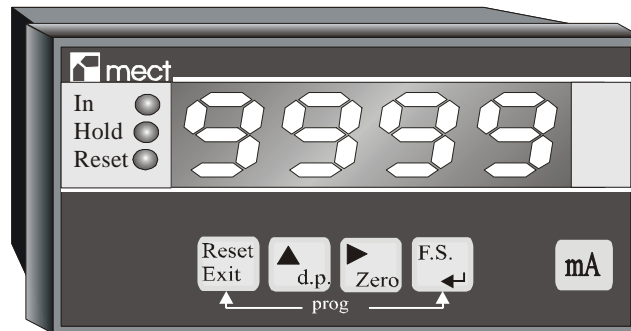

Reset
Exit : Zeroed reading. In menu fast exit

▲
d.p. : increments blinking digit in menu or decimal point set-up

▶
Zero : shifts blinking digit in menu or setup of reading scale start point

F.S.
◀ : set up of reading scale end point

Reset
Exit + F.S.
◀ : enter to the menu

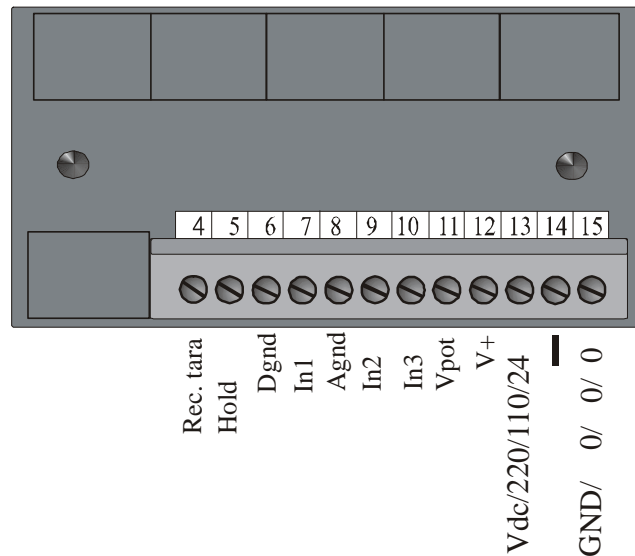
TERMINAL BOARD DESCRIPTION

Terminal 12

- transducer power supply (14V)

Terminals 13 and 15

- instrument power supply (Vcc, Vpt, 24Vac, 110Vac, 220Vac); if power supply "Vcc" the terminal 15 \equiv terminal 6 and 8

Terminal 11

- potentiometer power supply (2,0V)

Terminals 7, 8

- current input measure (terminal 8 = gnd)

Terminals 9, 8

- 0÷10Vdc input measure (terminal 8 = gnd)

Terminals 10, 8

- 0÷2Vdc input measure (terminal 8 = gnd)

Terminals 11, 10, 8

- potentiometer input (terminal 8 = gnd; terminal 10 = input; terminal 11 = potentiometer power supply)

Terminal 5

- Hold: shortcircuiting terminals 5 and 6 will memorize the reading

Terminal 4

- Recovery tara:

1) Terminals 4 - 6 open: the reading is the same as the programmed values

2) Terminals 4 - 6 closed: at the moment the terminals become shortcircuited the display is zeroed (rec.tara)

1.1.3 WIRING DIAGRAM

Connection for current input and 2 wire transducer

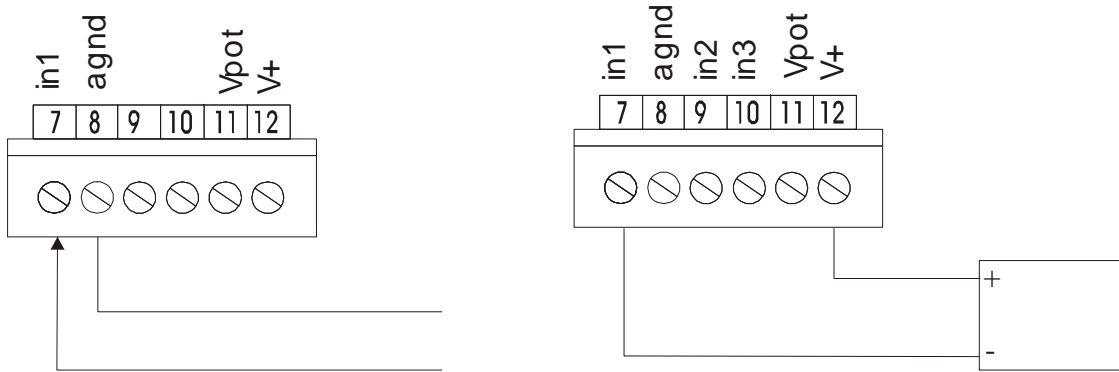

Connection for voltage input and 3 wire transducer

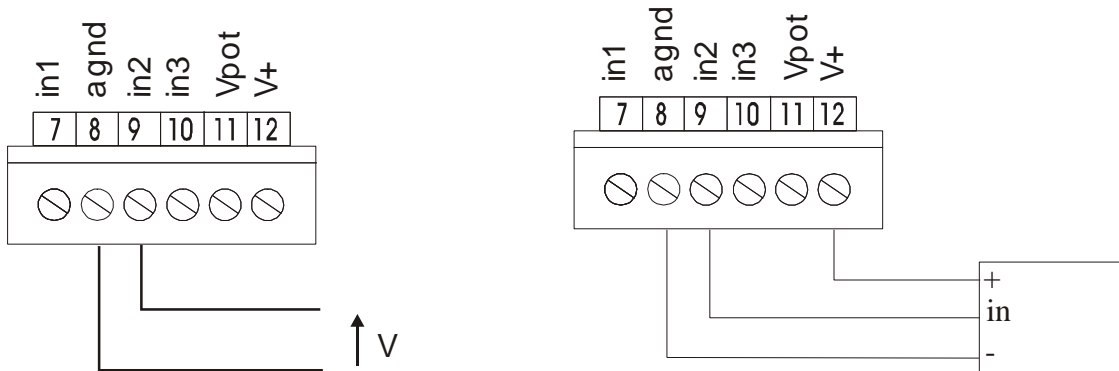

Connection for potentiometer input and 2Vdc

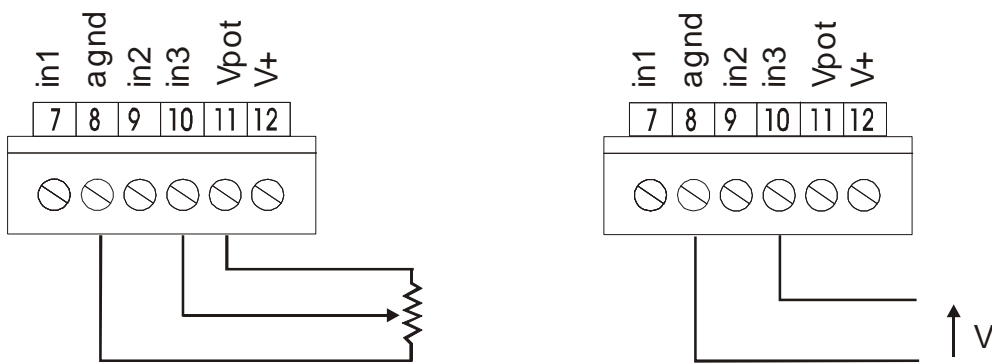



2.0 INSTALLATION NOTES

2.1 INSTALLATION PROCEDURE

- 1- Individuate the type of desired input and use the relative wiring diagram (for DC and AC current inputs 7 and 8 terminals; for 0÷10dc input 9 and 8 terminals; for potentiometer input 8, 10 and 11 terminals; for 0÷2Vdc input 10 and 8 terminals)
- 2- Switch on the instrument
- 3- Enter in the menu and select in “SCAL” item the requested input. See the following table:

Table 2

n seq.	Touch key	Written on display	NOTE
1	FS ↵ + Reset/ Exit	PASS	Touch “FS ↵“ + “Reset/Exit” key for 3 seconds
2	FS ↵	0 000	Digit the personal password ** (confirm with " FS ↵")
3	▲ d.p.	CPAS	CHANGE PASSWORD (if required see paragraph)
4	▲ d.p.	SCAL	INPUT SELECTION
5	FS ↵	0 - 10	If MP40 101 model the inputs are: 0 – 10: input 0÷10Vdc 0 – 2 : input 0÷2Vdc Pot : potentiometer input tA : input TA/5A If MP40 102 model the inputs are: 0 – 10: input 0÷10Vdc 0 – 2 : input 0÷2Vdc Pot : potentiometer input 4 - 20 : ingresso da 4/0÷20mA To change use "▲ d.p." key and confirm with " FS ↵"
6		SCAL	
7	Reset Exit	measure	To exit from programming area

- 4- Use the zero key to set up the value that must coincide with the minimum input value (beginning scale of the instrument).
- 5- Use the “FS ↵“ key to set up the value that must coincide with the maximum input value (full scale of the instrument).

- 6- Use the d.p. key to set up the decimal point as required
- 7- to execute the set up with the dedicate keys see paragraph “How to operate the instrument”.
- 8- For automatic zeroing check the recovery Tara function.
- 9- To set up other input parameters, see paragraph: “Instrument set up”.
- 10- To set up potentiometer input, see paragraph: “Potentiometer input set up”

2.2 HOW TO OPERATE THE INSTRUMENT

Please use the specific keys on the front in order to calibrate the instrument. With the ZERO key set up the reading value that is in line with the beginning of the input scale, then with the F.S. key set up the reading value which coincides with the end of input scale, with the dp key you should set up the decimal point.

WARNING : This type of programming can be realized by using the d.p., ZERO, and FS keys if the keys are enabled. See paragraph “Instrument set up”

There now follow example of zero calibration which are also true for end scale using the personalized keys F.S..

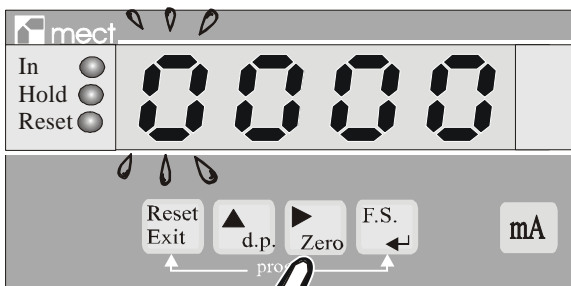

1st OPERATION

Touch the zero key. The display will visualize the value which it keeps in memory with the first left hand digit flashing.

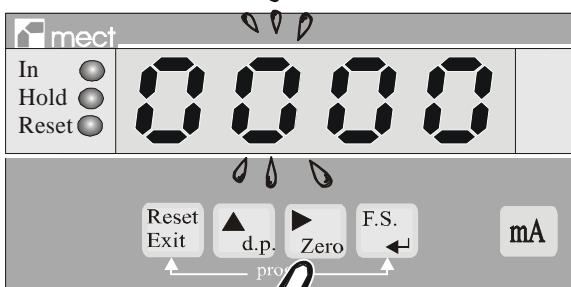

2nd OPERATION

Touch the “▶ zero” key to move the flashing number to the right.

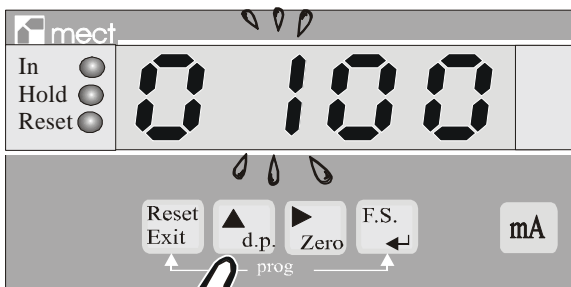
**3rd OPERATION**

Touch the “ \wedge d.p.” key to increase the flashing value.

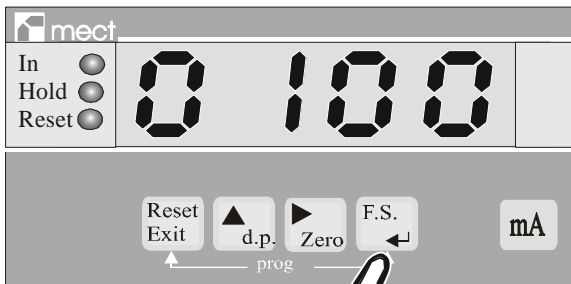
**4th OPERATION**

Confirm the programmed number by touching the 'FS \leftarrow ' key.

To program the decimal point observe the following indications.

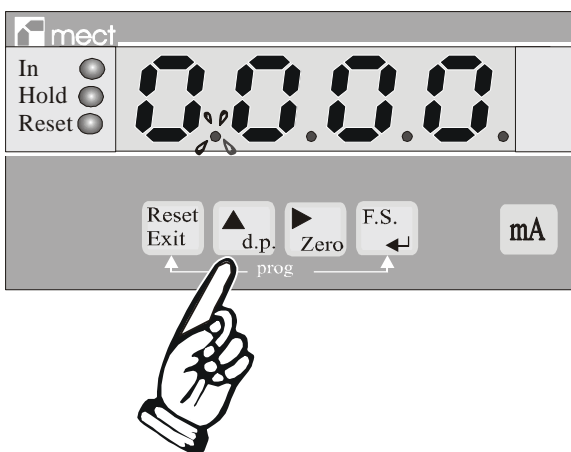

Touch the “ \wedge d.p.” key with the instrument in measuring mode. A decimal point will light up. In order to move this point touch the indicated key until the desired point is reached and then confirm with “FS \leftarrow ”

2.3 RECOVERY TARA FUNCTION

For “Recovery Tara” we mean a function that when in use zeroes the instrument readings. The Recovery Tara function can be enable from “Reset / Exit” key or shortcircuiting terminals 4 and 5. At the moment when the terminals 4 and 5 are short circuited or “Reset / Exit” key is pressed, zero is displayed and the reading zeroed. This operation is indicated when the led 'Reset' lights up on the instrument front.

Let us assume that the instrument, linked to a transducer, indicates a 100kg number. Shutting down the connection between terminals 4 and 5 will zero the instrument reading, thus rendering the indications negative for weight values that are less than 100 Kg and positive for values that are greater than 100 Kg.

N.B. The “reset display” function clears the current display value by the menu item “nert” il is possible to store the clear value at power off (see table 3).

2.4 INSTRUMENT SET UP

By using a hidden menu which is accessed by pushing together the two keys “Reset Exit” and “FS ↵”, it is possible to programme certain items of secondary importance which are protected by a password code. These setups are explained in the following table.

IMPORTANT

For the programming of the instrument display parameters there are four codes: ISI, ISL, FSI, and FSL. These menu items allow the setup of the co-ordinates which process the instrument readings. The first co-ordinate is formed by ISI and ISL. ISI is the initial value of the input scale which coincides with that written in the instrument label (0 mA, 4 mA, 0 V, Etc..) while ISL is the corresponding instrument display value. The second coordinate is formed of FSI and FSL. FSI is the bottom scale input value which coincides with that written on the instrument label (20 mA, 100 mV, 10 V, etc..), while FSL is the corresponding instrument display value. After calibrating the instrument it is possible to correct any unbalances in the transducer by using the menu item “OFFS”.

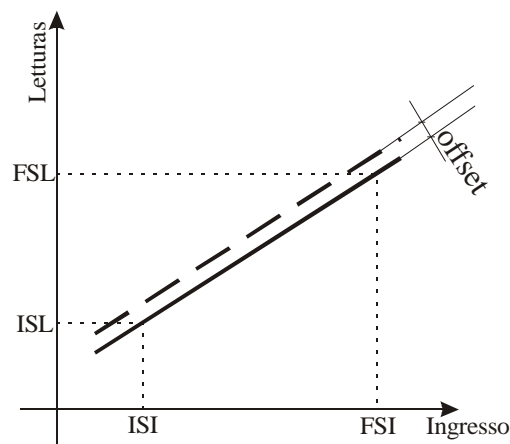

Table 3

n seq.	Touch key	Written on display	NOTE
1	FS ↵ + Reset/Exit	PASS	Touch “FS ↵“ + “Reset/Exit” key for 3 seconds
2	FS ↵	0 000	Digit the personal password ** (confirm with " FS ↵")

n seq.	Touch key	Written on display	NOTE
3	▲ d.p.	CPAS	CHANGE PASSWORD (if required see paragraph)
4	▲ d.p.	SCAL	INPUT SELECTION
5	▲ d.p.	AbOF	ZERO AND END SCALE ENABLED
6	FS ↵	on	on = zero and FS keys in use; OFF = zero and FS keys out of use. To change use "▲ d.p." key and confirm with " FS ↵"
7		AbOF	
8	▲ d.p.	Abrt	CLEAR DISPLAY ENABLED (Reset)
9	FS ↵	on	on = "Reset" key enabled OFF = "Reset" key disabled To change use "▲ d.p." key and confirm with " FS ↵"
10		Abrt	
11	▲ d.p.	AbPd	DECIMAL POINT ENABLED (d.p.)
12	FS ↵	on	on = d.p. key in use OFF = d.p. key out of use. To change use "▲ d.p." key and confirm with " FS ↵"
13		AbPd	
14	▲	nErt	MEMORIZING DISPLAY CLEAR FUNCTION
15	FS ↵	On	On = memorize the display clear function at the switching off OFF = the instrument loses the display clear function value at the switching off Press "▲" key until you will see the req. item **(confirm with " FS ↵")
16		nErt	
17	▲ d.p.	FIL	READOUT FILTER
18	FS ↵	8	Press "▲ d.p." key until the display shows the number of averages required. 0= no filter 2, 4, 8, 16, 32, 64: average filter (for alternate inputs use >16 number). Press "FS ↵" to confirm.
19		FIL	
20	▲ d.p.	ISI	START INPUT SCALE
21	FS ↵	0000	Insert the input value with which should represent the initial scale reading. ** confirm with " FS ↵"
22		ISI	
23	▲ d.p.	ISL	START READING SCALE

n seq.	Touch key	Written on display	NOTE
24	FS ↵	0000	Insert the reading value which coincides with the input value. confirm with " FS ↵"
25		ISL	
26	▲ d.p.	FSI	END INPUT SCALE
27	FS ↵	1999	Insert the input value with which should represent the END scale reading. ** confirm with " FS ↵"
28		FSI	
29	▲ d.p.	FSL	FULL SCALE READING
30	FS ↵	1000	Insert the reading value which coincides with the input value. confirm with " FS ↵"
31		FSL	
32	▲ d.p.	OFFS	ZEROING
33	FS ↵	0000	Use this item to effect a zeroing that will be retained in memory. The number written can vary between -999 and 2000. ** confirm with " FS ↵"
34		OFFS	
35	▲ d.p.	ZEFI	FIXED ZERO SELECTION
36	FS ↵	On	OFF = standard display On = fixed zero display . To change use the " ▲ d.p." key and confirm with " FS ↵"
37		ZEFI	
38	▲ d.p.	dEF	DEFAULT PARAMETERS (see paragraph)
39	FS ↵	on	on= default parameter setup; OFF=no def.param. set up. To change use " ▲ d.p." key and confirm with " FS ↵"
40		dEF	
41	▲ d.p.	“measure”	

** To modify the preset number follow the procedure shown under the 'SETUP' paragraph.

2.5 POTENTIOMETER INPUT SET UP

2.5.1 THEORETICAL EXAMPLE

Check the feasibility of this calibration.

Let us assume that we have to link up a 10 revolution potentiometer and that we have to programme the following reading:

2.5 revolutions reading +100

8 revolutions reading +900

To calculate the data to be programmed in the instrument, it is necessary to take into account the following considerations. The potentiometer to be read is divided hypothetically into 9999 points, this number being aligned with the mechanical condition of the transducer on test. In our example:

$$\frac{10 \text{ revolutions}}{9999 \text{ points}} = \frac{2.5 \text{ revolutions}}{X \text{ points}} ; X = \frac{2.5 * 9999}{10} = 2500 \text{ (ISI)}$$

$$\frac{10 \text{ revolutions}}{9999 \text{ points}} = \frac{8 \text{ revolutions}}{X \text{ points}} ; X = \frac{8 * 9999}{10} = 8000 \text{ (FSI)}$$

This application should be programmed as follows:

ISI = 2500

ISL = 100

FSI = 8000

FSL = 900

2.5.2 PRACTICAL EXAMPLE

In this example we consider an application for which it is not possible to make a precise calculation of the potentiometer variation, it therefore being necessary to use empirical methods. Let us suppose a linkup of the potentiometer with the instrument and to be able to assign two fixed points to the course of the transducer A and B. The system calibration requires the following data.

POINT A = 250

POINT B = 1500

switch on the instrument with the calibration values set-up with these numbers:

ISI = 0000

ISL = 0000

FSI = 9999

FSL = 9999

OFFS = 0000

Position the potentiometer in line with point A and note the display reading (ISI), position the transducer in line with point B and note the display reading (FSI). After this operation it is necessary to proceed with the parameter programming by following the indications in this table:

ISI = value noted in coincidence with A

ISL = 250

FSI = value noted in coincidence with B

FSL = 1500

2.6 FIXED ZERO FUNCTION

The instrument can be programmed to visualize the range $-1990 \div 9990$ with the units number blocked at zero. To set up this function it is necessary to programme 'on' using the hidden menu item ZEFI (see table 2).

2.7 DEFAULT PARAMETERS (dEF)

In order to bring back the factory parameters as quickly as possible it is sufficient to put the dEF function into use, which resets all the functions to factory default standards by eliminating all error situations.

WARNING: Setting up this function eliminates all the current instrument programming.



3.0 FILTER FUNCTION

The internal rate time of the instrument is 30mSec. Normally, it is necessary to slow down the readout to prevent unstable readings. To stabilize the readout it is possible to use "FIL" item. This voice can be programmed from 2 to 64: this number means how many values compose the average on the display. To exclude the "Filter function" it is necessary to program "0" number. The display adjournment time depends from the programmed filter in the following way:

Table 4

Programmed filter	Display agjournment time
0	30mSec
2	60mSec
4	120mSec
8	240mSec
16	480mSec
32	960mSec
64	1920mSec

If the instrument is working with alternate input, it is better to programm the filter upper then 16.



4.0 PASSWORD FUNCTION

The user should save the programmed information from misuse by using the password function.

The instrument comes supplied with a password code =0, but any number between 0 and 9999 can be set up as an access code in order to modify the instrument functioning (for programming personal password number check with the following table).

The use of the password code is requested each time the user wishes to gain access to the programming functions. The instrument, after having obtained the password number then behaves in two different ways.

1) **correct N.Pass** The user can use the programming menu in order to modify a function or number.

2) **incorrect Pass** The user can gain access to the programming menu only in order to check the numbers and functions already programmed, but never to modify them.

WARNING. The number programmed under the c.PAS menu item by the user must be reinserted under the PASS heading each time that the programming menu is used for insertion of the variables. If the user does not remember the exact secret code, then it is necessary to call our service centre.

Table 5

n seq.	Touch Key	Written on display	NOTE
1	FS ↵	PASS	Touch 'FS ↵' key
2	FS ↵	0 000	** (confirm with 'FS ↵')
3	▲ d.p.	C.PAS	PERSONAL PASSWORD NUMBER
4	FS ↵	0 000	Enter Password Number between 0 and 9999 . ** (confirm with 'FS ↵')
5		C.PAS	
6	Reset Exit	“measure”	Touch 'Reset Exit' key to exit from the menu

** To modify the preset number follow the procedure shown under the 'SETUP' paragraph.



5.0 SET UP

The following paragraph shows the steps necessary for programming the various menu items. The example that follows is related to programming under the 'CPAS' menu item, but the procedure is valid for all the menu items that need a numerical setup.

Table 6

n seq.	Touch Key	Written on display	NOTE
1		CPAS	Example of password change
2	FS ↵	0 000	The display appears as a flashing number
3	▶ zero	0 0 00	Pressure on the “▶ zero” key moves the flashing number right
4	▲ d.p.	0 1 00	Pressure on the “▲ d.p.” key increases the flashing number
5	FS ↵	CPAS	The number is memorized and the display returns to selected menu item

**6.0 NOTES**

The instrument does not have a power on switch and a fuse, but it immediately switches on when the correct voltage is applied (see the operating voltage on the instrument label). Keep the power line separate from the signals lines.

For security reasons, it is necessary to provide externally a two phases switch and a protective fuse near the instrument with easy access for the user.

Avoid the presence of others power elements, humidity, acid, heat sources, etc..

Mect srl is not responsible for damages to humans or goods for an improper use of the instrument or not conforming to the characteristics of its instrument.

In mect srl there is an help desk office.