

USER'S MANUAL
MPNC035 01 series
4 analog output



Via Enrico Fermi, 57/59 - 10091 ALPIGNANO (TO)
☎ Telefono: +39 (0)11 9664616 Fax: +39 (0)11 9664610
E-mail: srlmect@mect.it - C.F. e P.I. 04056380019

ME7057_00
07/16

INDICE

INDICE.....	1
1.0 Introduction	1
1.1 Staff skill.....	1
1.2 Symbols	1
1.3 Glossary	1
1.4 Security	2
2.0 MPNC System.....	2
2.1 System Description.....	2
2.2 NORMS	2
2.3 Technical Data.....	3
2.4 Installation	4
2.4.1 Distances.....	4
2.4.2 Component Adding and Removal	5
2.4.3 Assembly sequence.....	5
2.4.4 DIN guide and TBUS properties	6
2.4.5 Wiring Description	6
2.4.6 Output connections	7
2.5 LED.....	9

1.0 Introduction

To ensure fast installation of described devices, we recommend to carefully read the information in this manual.

1.1 Staff skill

The products described in this manual are for use only by personnel with experience in PLC programming, or technical specialist in the use of an electrical-driven automation.

MECT Srl is not liable for failures caused by improper usage and damage to MECT devices or other devices, due to the non-compliance to the instructions contained in this manual.

MECT Srl offers technical assistance through its technical office.

1.2 Symbols



Danger

Follow instruction to avoid damages to people or devices.



Warning

To protect the device adhere to instructions.



Attention

Conditions to be met for an effective installation



ESD (Electrostatic Discharge)

Attention: possible component damage due to electrostatic discharge



Note

Correct installation step



Further information

1.3 Glossary

Coupler: MPNC005 or MPNC010

Terminals: MPNC020 for digital input/output; MPNC030 for analog input; MPNC035 for analog output

System: coupler together with Terminals.

TBUS: internal communication bus between Coupler and terminals.

1.4 Security

**Attention**

Power down devices before any operation.

**Attention**

MPNC035 must be installed in closets or cabinets accessible only by qualified personnel through a key or a tool.

**ESD (Electrostatic Discharge)**

The modules contain electronic components that can be destroyed by electrostatic discharge. Every time you handle the modules, be sure that you and the system are connected to ground.

The device does not have an ON-OFF switch and an internal fuse. Power up occurs immediately after applying the correct voltage (please check the power source voltage indicated on the nameplate of the device under "Power"). Provide a supply line as direct as possible and separated from the line that supplies high power components.

For safety, you must provide a two-phase disconnecting switch with fuse located near the device and easily accessible by the operator. Avoid to mount in the same power panel high power devices (contactors, motors, drives, ect.), or excessive moisture, heat and corrosive gases. The devices must be powered by an instrument transformer or by a SELV power supply.

2.0 MPNC System

2.1 System Description

Sytem composed by a coupler (MPNC010) or (MPNC005)

MPNC is a modular system made by a coupler/controller (MPNC010 or MPNC005) and a set of terminals for different kind of signals (MPNC020; MPNC030 ...). The coupler is a CANopen interface in the MPNC010 version and Modbus interface in the MPNC005 version, also processes data from the terminals and makes them available to the fieldbus. The coupler can be connected to both analog and digital Terminals; communication between them is provided by an internal bus, named TBUS.

2.2 NORMS

Reference standards are listed in the CE conformity declaration on the Mect web site.

2.3 Technical Data

Mechanic	
Material	Polycarbonate, Polyamide 6.6
Dimension S W x H x L - Terminal	- 22.5 mm x 108 mm x 115 mm
Power supply	24 Vdc \pm 15%
Max Power Dissipation	0.6 W excluding power toward loads
Max current for each current output	20mA _{dc}
Max voltage for each voltage output	10V
Max voltage for PWM output	Valim
Installation	DIN 35
Climatic Environmental Condition	
Operative Temperature	0 °C ... 55 °C
Storage Temperature	-20 °C ... +85 °C
Relative Humidity	5 % a 95 % senza condensazione
Safe Electrical Isolation	
Air and creepage distance	acc. to IEC 60664-1
Degree of Pollution acc. o IEC 61131-2	2
Protection degree	
Degree of Protection	IP 20

Signal specification			
Current output	0 ÷ 20.000mA:	0 ÷ 20000 5 digit resolution	Current output max load: 500 ohm
PWM NPN output	0 ÷ 100% Frequency 250Hz, Max voltage V _{power supply}	resolution 1%	Output impedance 10kΩ
Precision	0,5%		

**Attention**

Install devices in an environment not above 55 °C

Dimensions

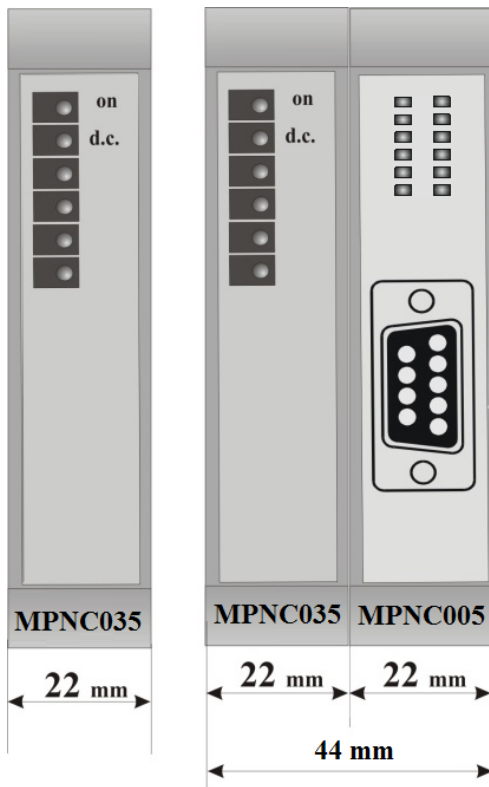

Figure 1 Dimensions

2.4 Installation

2.4.1 Distances

The system must be installed allowing enough space for heat transfer, installation and wiring. Avoiding wires overlapping also prevents electromagnetic compatibility problems.



Figura 2 Spazi

2.4.2 Component Adding and Removal

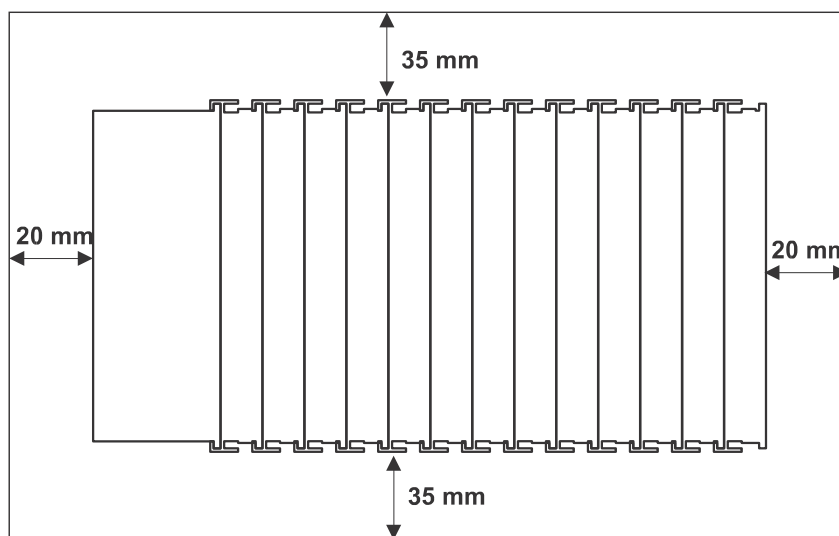

Attention

Be sure that devices are not powered when performing component adding or removal.

2.4.3 Assembly sequence

The insertion and removal of a single terminal is made by using the hook at the base of the terminal as shown.

The assembly must begin with the insertion of the coupler (MPNC010 or MPNC005). After that, the required terminal are inserted in sequence. The DIN rail mounting is ensured by the spring coupling of each terminal.

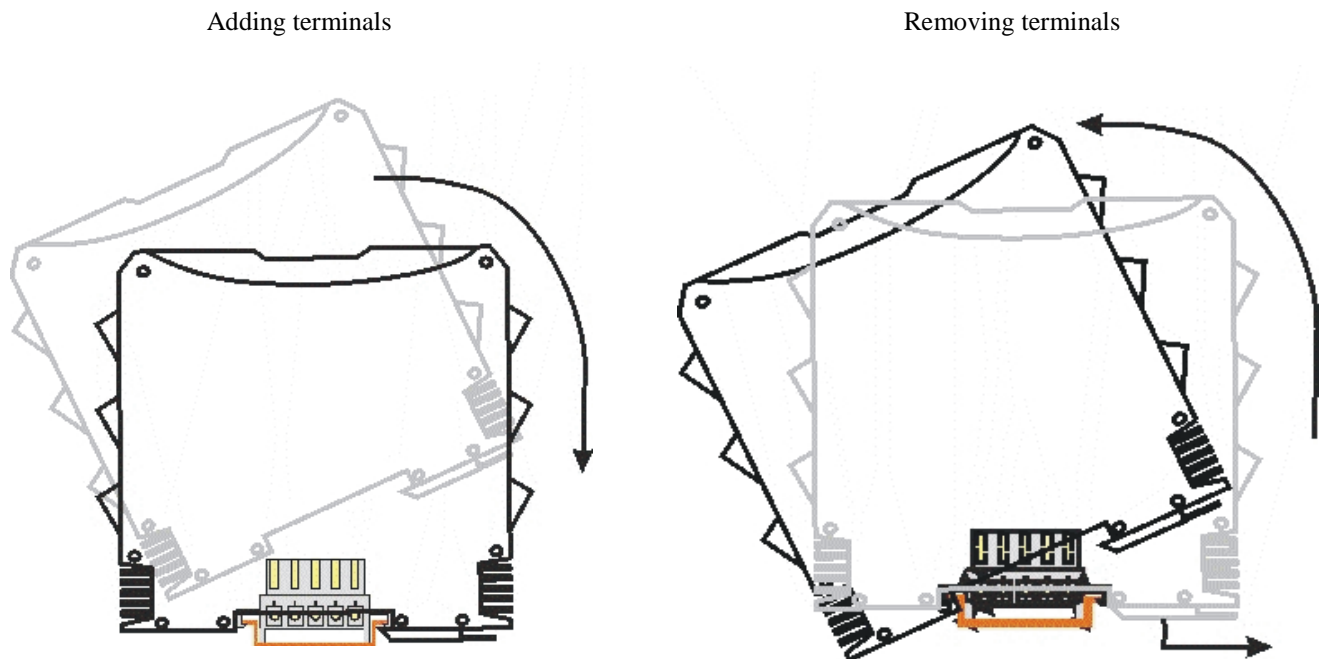

Figure 3 Insertion and removal of a terminal

The instruments must be assembled on TBUS as shown below. MPNC010 or MPNC005 must be positioned to the right and the nodes to the left.

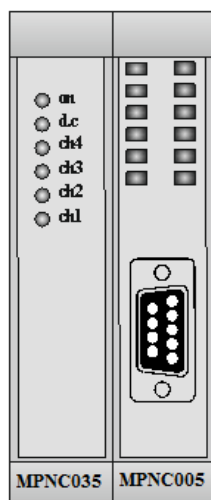

Figure 4 Assembly

2.4.4 DIN guide and TBUS properties

All modules must be locked to a DIN guide type EN 50022 (DIN 35) on which there are the TBUS connection modules that communicate with terminals.

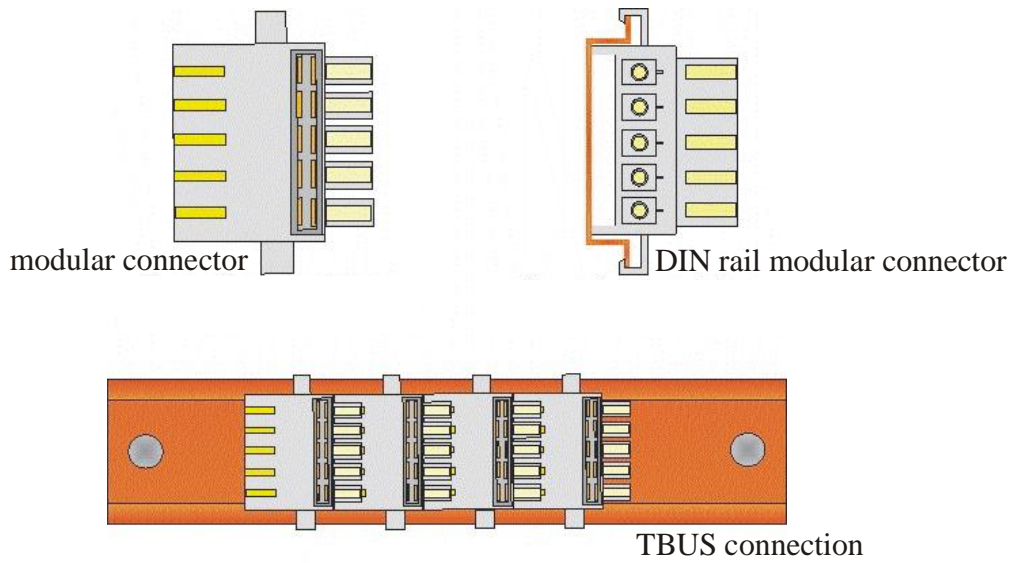

Figure 5 TBUS

2.4.5 Wiring Description

MPNC005 and nodes daisy chain connection

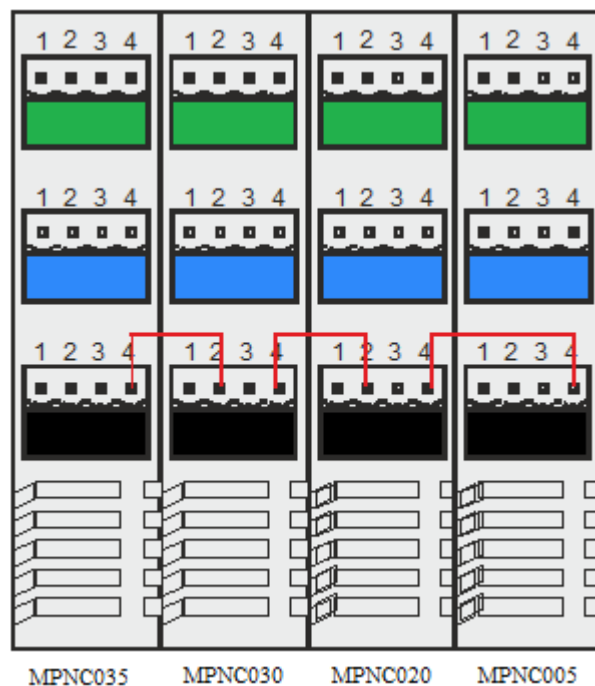

Figure 6 Daisy chain MPNC005



Figure 7 terminal blocks

2.4.6 Output connections

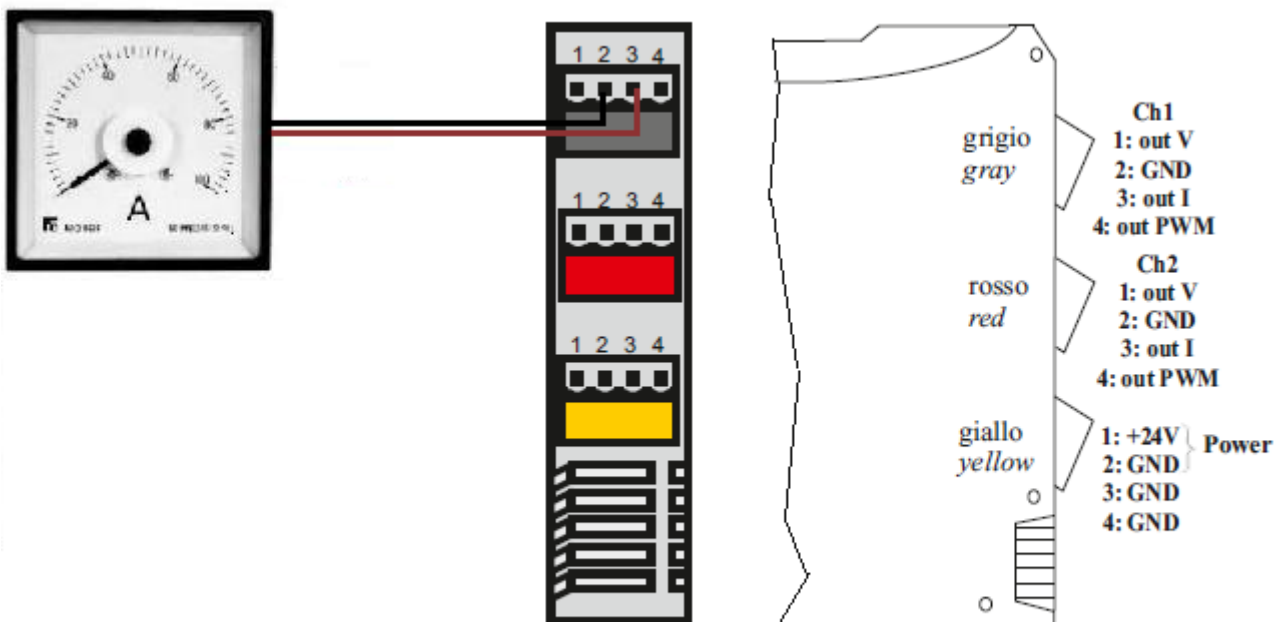

Figure 8 Current output connection

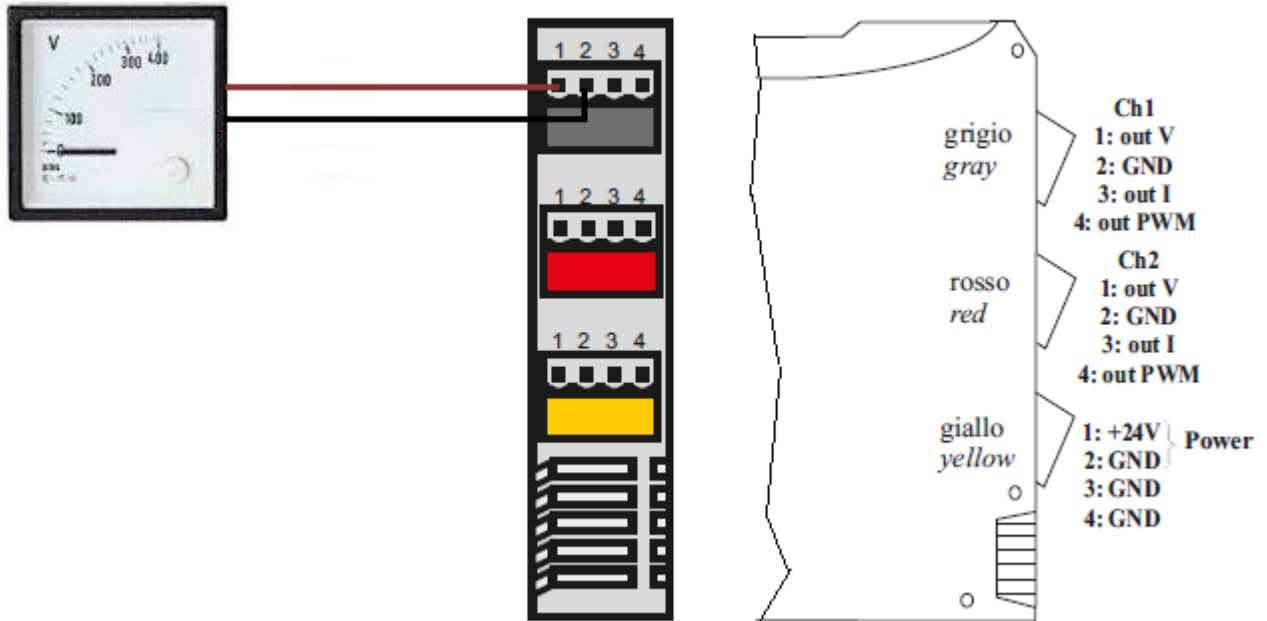

Figure 9 Voltage output connection

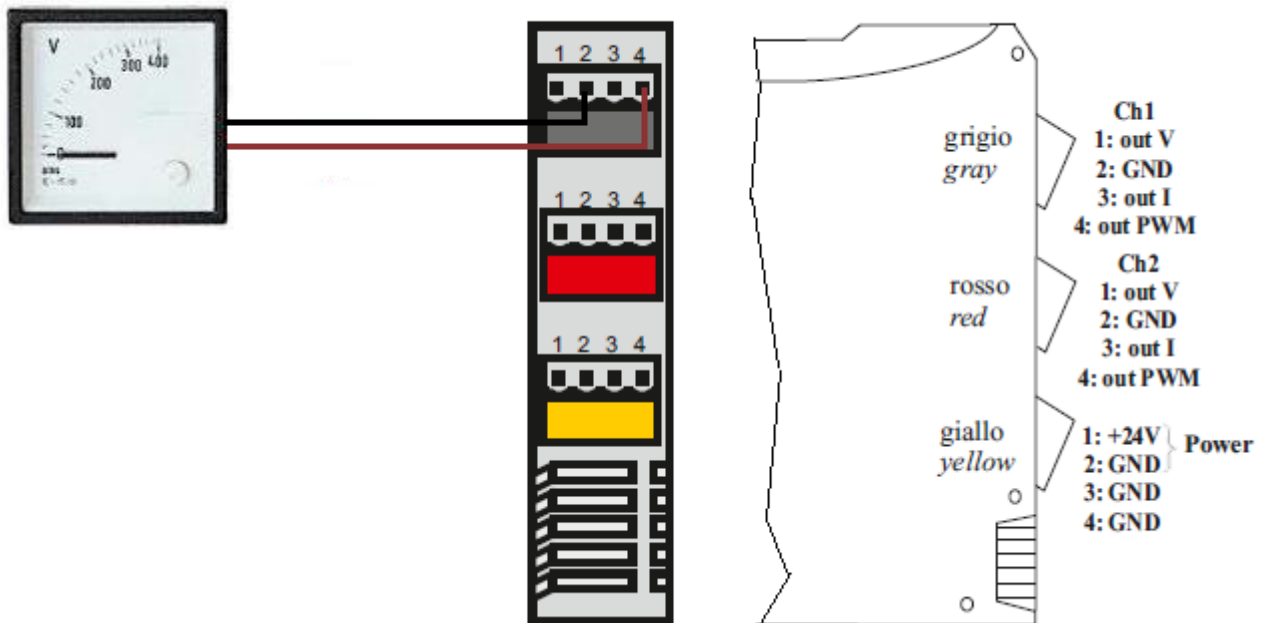

Figure 10 PWM output connection

2.5 LED

LED	Status	Description
On	Blinking	Terminal not configured
	On	Terminal configured
	Off	Terminal not powered
d.c	Off	Terminal is in reset state Cause: <ul style="list-style-type: none"> • daisy chain non is not connected • terminale is not powered
	On	daisy chain IN is correctly connected
Ch4	Off	Function OK
	Blinking	An out of range output is requested
Ch3	Off	Function OK
	Blinking	An out of range output is requested
Ch2	Off	Function OK
	Blinking	An out of range output is requested
Ch1	Off	Function OK
	Blinking	An out of range output is requested

